

INTRODUCTION

The easy and correct installation of asphalt shingles depends entirely on the roof deck being smooth, continuous, clean, and dry .

The roof deck can be built with wood materials (such as seasoned tongue or groove planks , plywood, cement and wood fibre board, etc.) properly supported, or with a light cement layer on top of the concrete deck.

MARKING OUT THE ROOF

- Mark a line xy orthogonal to the direction of maximum slope of the roof (usually parallel to the eaves and to the gutter and at 19,4 cm from the gutter) ;
- Mark along the line xy a point A in the centre of the pitch ;
- Mark points B e C, at either side from A (for example at 150 cm);
- Starting from B and C by using a chalk line as a compass, mark point D as near as possible to the Ridge.
- Join A with D;
- Mark a line parallel to line AD at a distance of 16,6 cm (z);
- Starting from the line xy, mark horizontal and parallel lines to the line xy, at a distance of 14,3 cm from each other up to the ridge (Pict. Nr. 1);

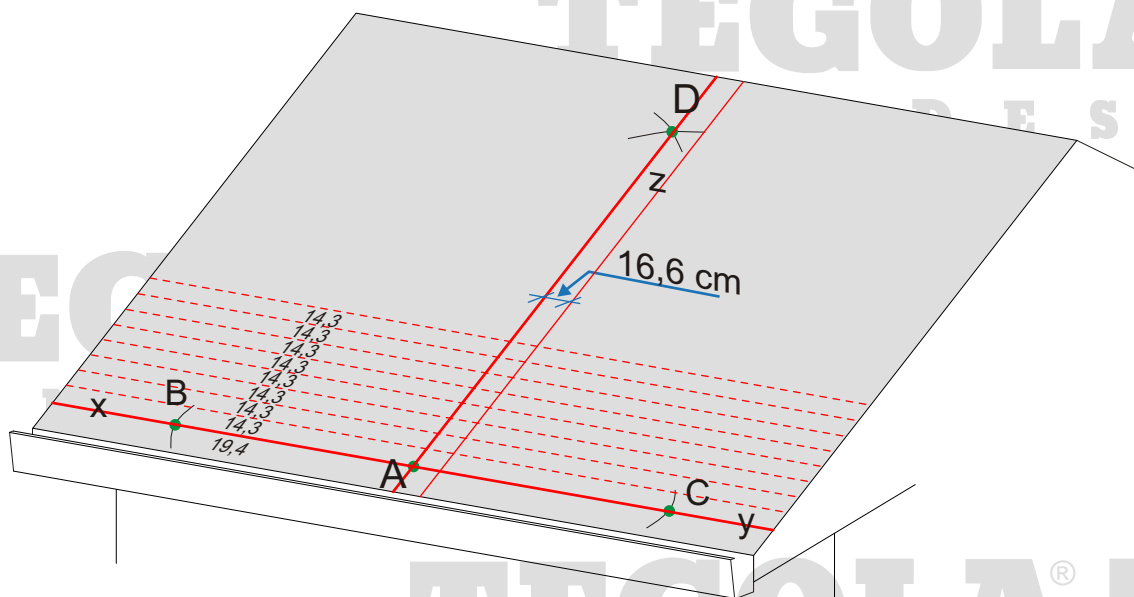

Picture Nr. 1 - Marking out the roof

INSTALLATION

- Apply a line of bituminous mastic “Bitustick” along the eaves (Pict. Nr. 3); trim the tabs from the bituminous shingle, remove the protection film to form the starter course (Pict. Nr. 2) and align it to the line z (see Pict. Nr. 3).
- As recommended for the starter course, remove the protection film from the reverse side of each shingle before installation.
- Install the first row of shingles along the line AD (Pict. Nr. 4).
- Install the second row of shingles along the line z (Pict. Nr. 4).
- Repeat this installation method until all pitches are completed.
- The trimming and aligning operations are simplified following the cuts on the upper edge of each bituminous shingle.

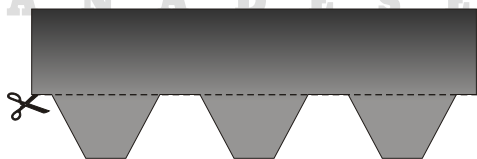

Picture Nr. 2 Trimming the tabs

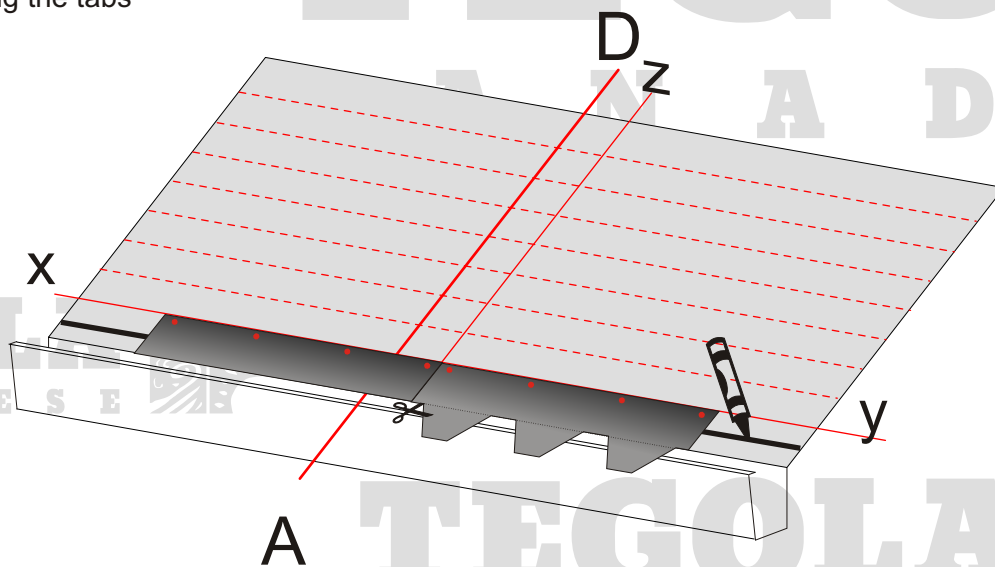

Picture Nr. 3 - Installation of the starter course

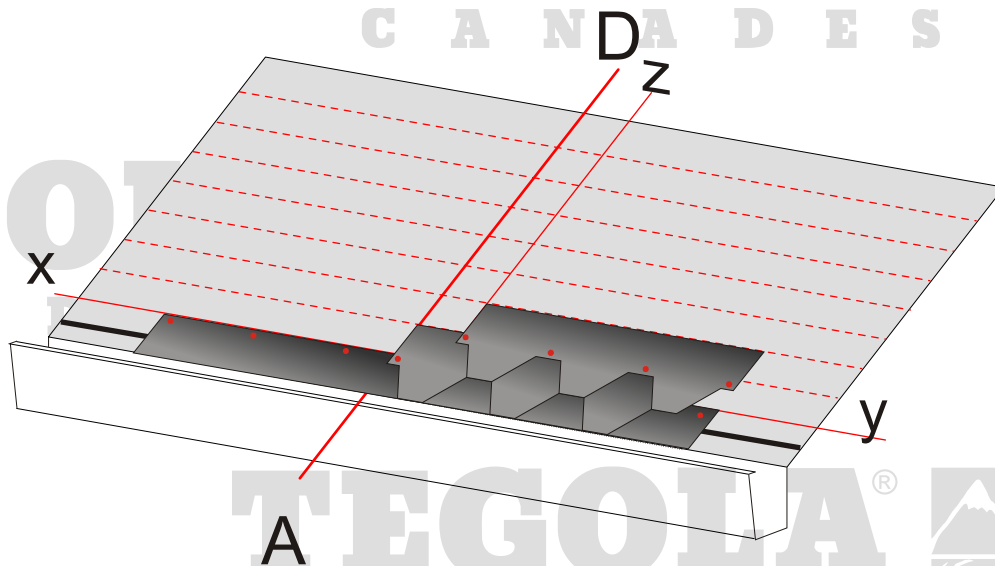

Picture Nr. 4 - Sequence of 2 shingles

SLOPES

Minimum slope for the installation of the shingles with nails is 35% (19 degrees)

For roofs in the mountainside or with a pitch longer than 7,00 ml, please visit our web site or contact our Customer Service.

FIXING WITH NAILS

Use large headed roofing nails for the roof, zinc plated or galvanized, high adherence, with a length suitable to the thickness and type of roof deck.

Apply 5 nails on each bituminous shingle, MOSAİK, positioned exactly as shown in Picture 5.

Make sure that the nails anchor also the underneath bituminous shingle.

N.B.: For slopes exceeding 160% (60 degrees) apply 6 nails on each bituminous shingle and double the number of nails on the second and third position from the left as shown in Picture 6.

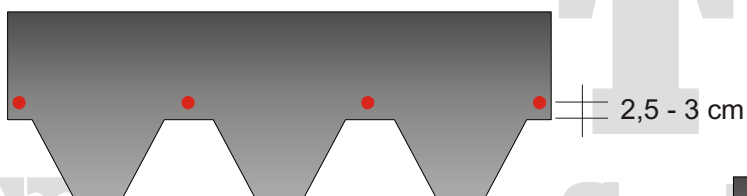

Picture Nr. 5

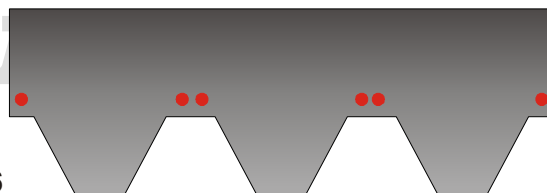

Picture Nr. 6

RIDGES

Install the last row of bituminous shingles up to the ridge line and then bend it over the exceeding part, in order to waterproof the ridge.

To obtain the ridges, cut the bituminous shingles into 3 pieces (Picture 7). Before installing remove the rivers side protection film, bend the piece of shingle and position them over the ridge line (see Picture 8). If necessary heat them on the reverse, sanded side.

Fix the ridges with 2 nails on each piece which will be overlapped by the following piece (Picture 8).

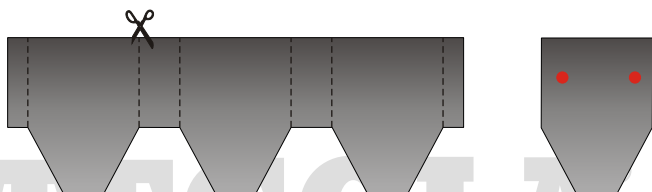

Picture Nr. 7- Cutting of the ridges

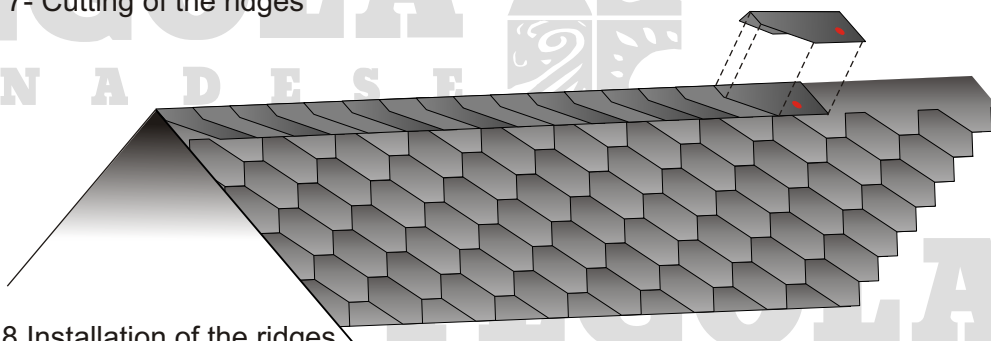

Picture Nr. 8 Installation of the ridges

VALLEY

Torch the membrane (100 cm wide) on the center line of the valley, then torch the shingles on into this membrane.

Type A) The bituminous shingles of the two pitches will cross each other going up to the other side of at least 25 cm from the center of the valley. Do not fix with nails at a distance less than 40 cm from the center of the valley (Pict. Nr. 9).

Picture Nr. 9 - Valley Type A
(crossed)

Apply a bituminous
membrane 100 cm wide.

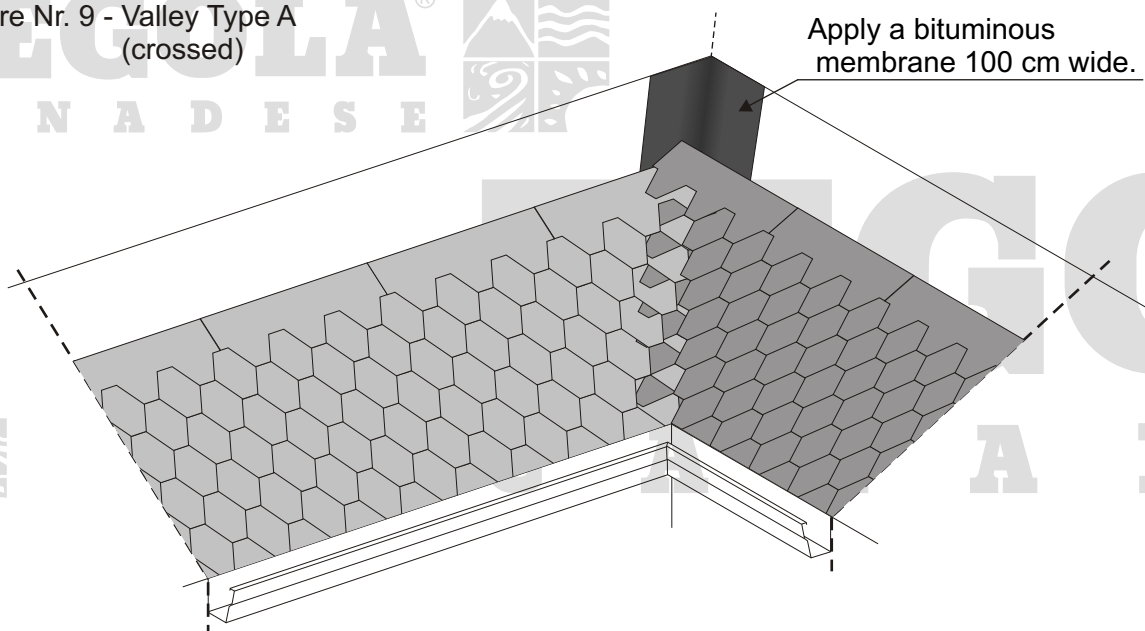

Type B) Install the bituminous shingles on one pitch of the roof overlapping the center of the valley by at least 25 cm. Install the shingles on the other pitch so that they slightly overlap the center of the valley.

Mark the center of the valley with the chalk line, cut the bituminous shingles of the second pitch following the marked line obtaining a linear cut along the center of the valley. Seal carefully along the cut with Bitustik. Do not fix with nails at a distance less than 40 cm from the center of the valley (Pict. Nr. 10).

Picture Nr. 10 - Valley Type B
(Cut)

Apply a bituminous
membrane 100 cm wide.

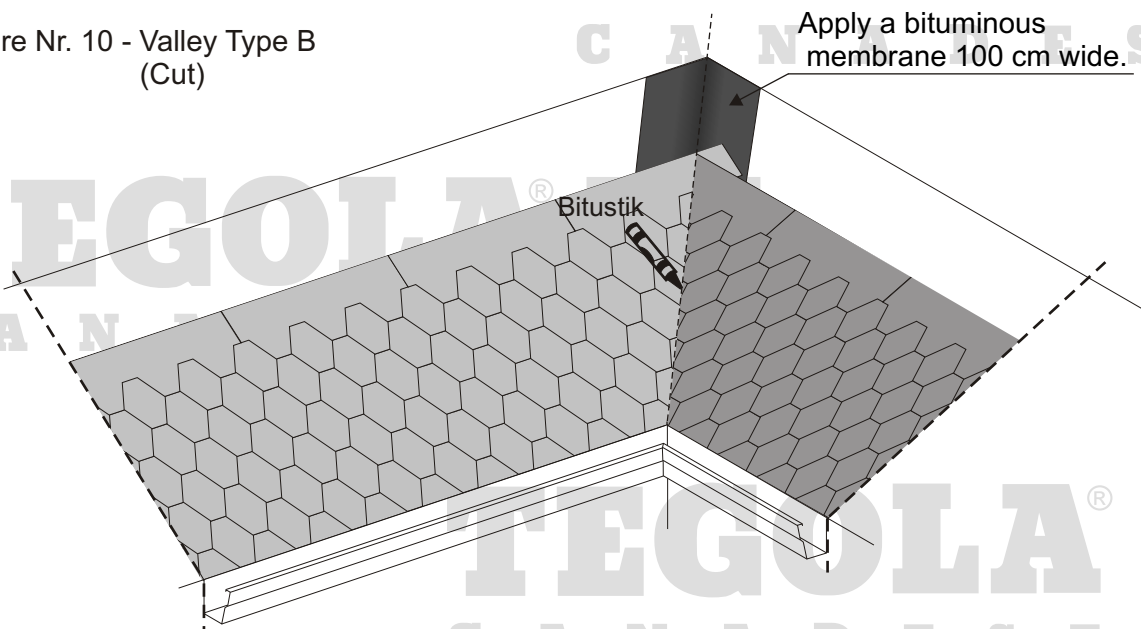

DETAILS

All the details (junctions, valleys, chimneys, etc..) can be carried out with flashings (copper, painted metal sheets, etc.) or bituminous membrane, and everything will be simplified by using the products TEGOLA CANADESE.

Roof accessories such as: roof windows, snow stoppers, aerators and other accessories from Tegola Canadese make the installation and finishing of the roof easier.

The shingles MOSAİK, are supplied with self-adhesive tabs that soften with the heat and stick the shingles together, avoiding the wind to lift them up. With cold weather or in very windy areas this does not automatically happen and the adhesive points have to be heated up with a torch, and the shingles have to be pressed down to assure that they stick together.

WARNING

- DO NOT STORE THE PALLET ONE ON THE TOP OF THE OTHER TO AVOID THAT THE BITUMINOUS SHINGLES STICK TOGETHER INSIDE THE BUNDLE.
- DO NOT EXPOSE THE PALLETS TO ATMOSPHERIC AGENTS NOR TO HEAT.
- USE ONE SINGLE PRODUCTION CODE FOR THE INSTALLATION OF ONE ROOF DECK
- AT THE TIME OF INSTALLATION THE SHINGLES' TEMPERATURE MUST BE NOT LESS THAN 5°C.



C A N A D

TEGOLA[®]
C A N A D E S E

TEGOLA[®]
C A N A D E S E

TEGOLA[®]
C A N A D E S E

TEGOLA[®]
C A N A D E S E