

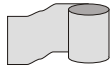

COMPACT CLIP

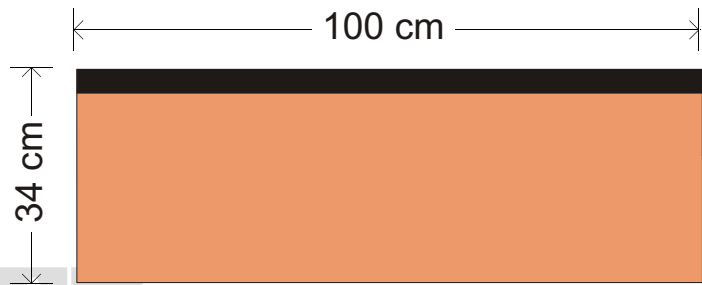

COMPACT STRIP



INTRODUCTION

The easy and correct installation of asphalt shingles requires a smooth, continuous, clean, and seasoned dry roof deck.

The roof deck can be built with wood materials (such as seasoned tongue or groove planks, plywood, cement and wood fibre board, etc.) properly supported, or with a light cement layer on top of the concrete deck suitable to torch on the bituminous membrane.

MARKING OUT THE ROOF

- Mark a line xy orthogonal to the direction of maximum slope of the roof (usually parallel to the eaves and to the gutter and at 32-34 cm from the gutter);
- Mark along the line xy a point A in the centre of the pitch;
- Mark points B e C, at either side from A (for example at 150 cm);
- Starting from B and C by using a chalk line as a compass, mark point D as near as possible to the Ridge.
- Join A with D;
- Starting from the line AD mark parallel lines on both sides at a distance of 50 cm (z), till completion of the whole slope;
- Starting from the line xy, mark horizontal and parallel lines to the line xy, at a distance of 29 cm from each other up to the ridge (Pict. Nr. 1);

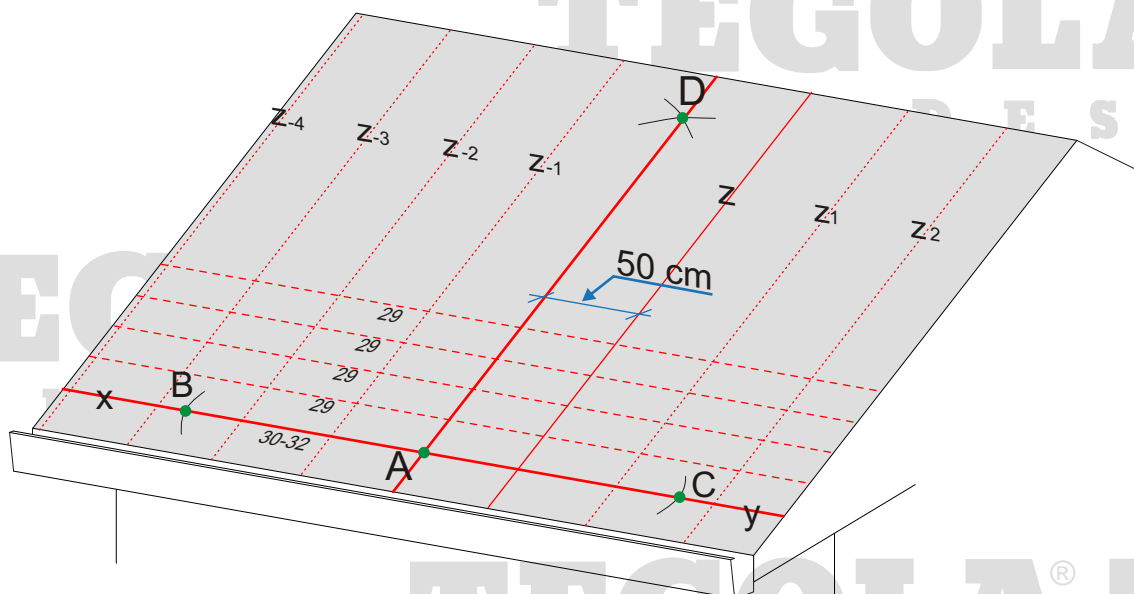

Picture Nr. 1 - Marking out the roof

INSTALLATION

- Apply a line of bituminous mastic “Bitustick” along the eaves (Pict. Nr. 2).
- Before the installation of the shingles, remove the protection film at the reverse side of them (Pict. Nr. 3); for a correct installation all the shingles should be gently manually curved.
- The first row starts by aligning the first PRESTIGE COMPACT shingle along the line AD (Pict. Nr. 4) and nail as shown in picture 5.
- Before the installation of the second row of shingles remove the protection of the self adhesive fascia (Pict. Nr. 4), and cut pieces of 34 cm of “Compact Strip” (Pict. Nr. 7) which will be installed at the center of the joints of the shingles (Pict. Nr. 6), taking care to press them down for a perfect adhesion. Don't remove the white film on the top side of the “Compact strip”.

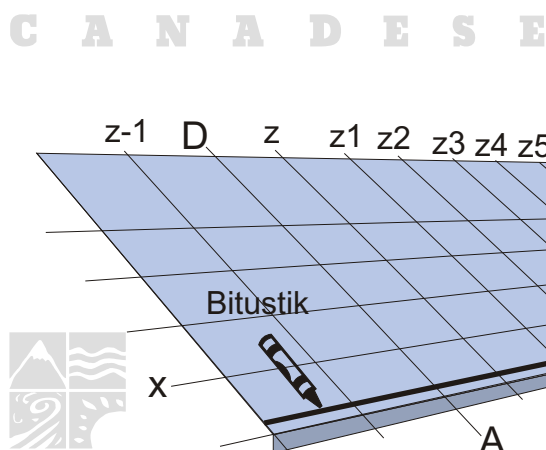

Picture Nr. 2 - Bitustik



Picture Nr. 3 - Protection film at the reverse side

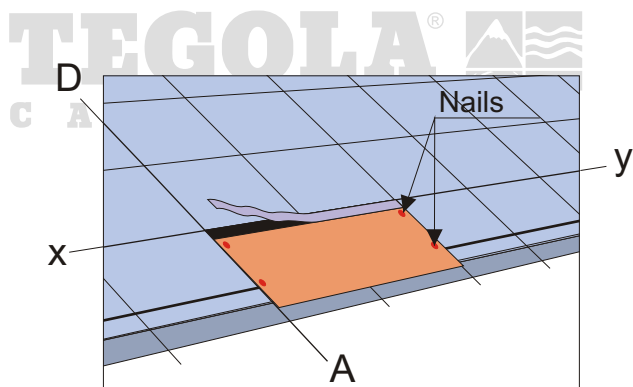

Picture Nr. 4 - Installation of the first shingle Compact

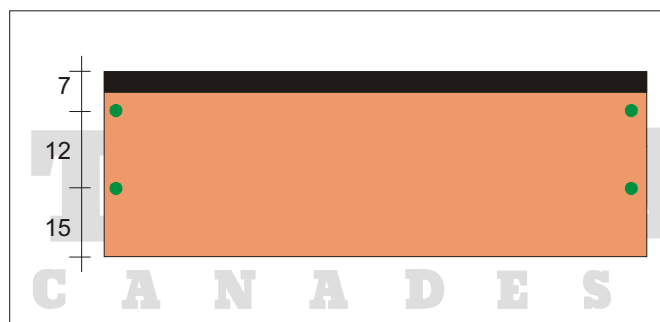

Picture Nr. 5 - How to nail the first row of shingles

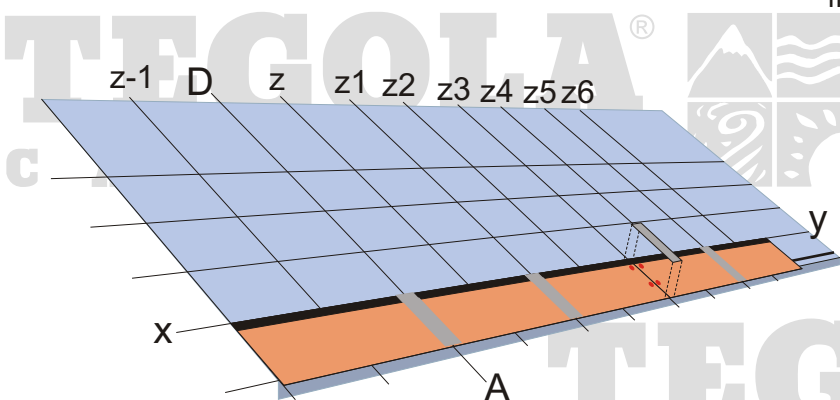

Picture Nr. 6 - Installation of Compact Strip

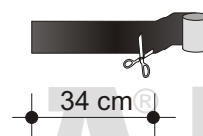

Picture Nr. 7 - to cut of “Compact Strip”

- Install the "Compact Clip" aligning the central notch on the line AD and nailing it into the proper holes (Pict. Nr. 8).
- The second row starts by aligning PRESTIGE COMPACT shingle along the line z (Pict. Nr. 9) then nail;
- remove the protection of the self adhesive fascia and install the "Compact Strip" (Pict. Nr. 9);
- Press the "Compact Strip" down, cover the sealed joint with Compact Clip (Pict. Nr. 10) and fix it by placing nails in the proper holes.
- Repeat this installation method until all pitches are completed.

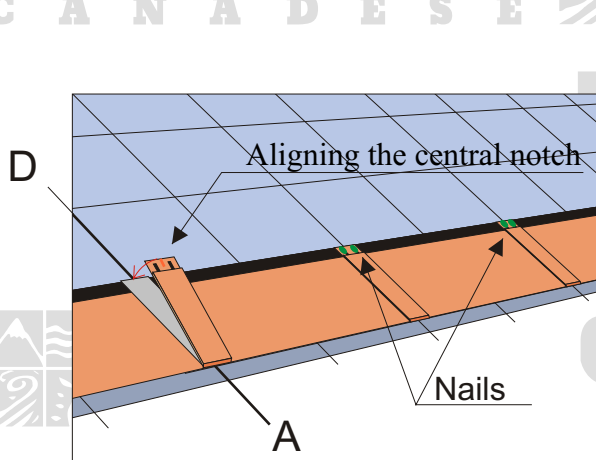

Picture Nr. 8 - Installation of Compact Clip

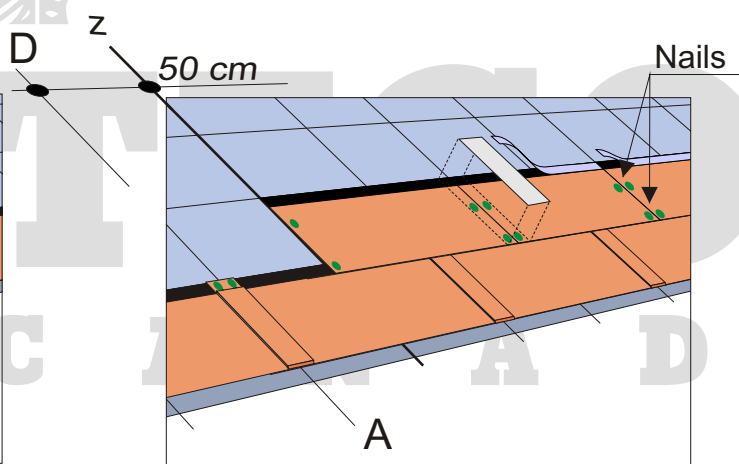

Picture Nr. 9 - Second row of shingles

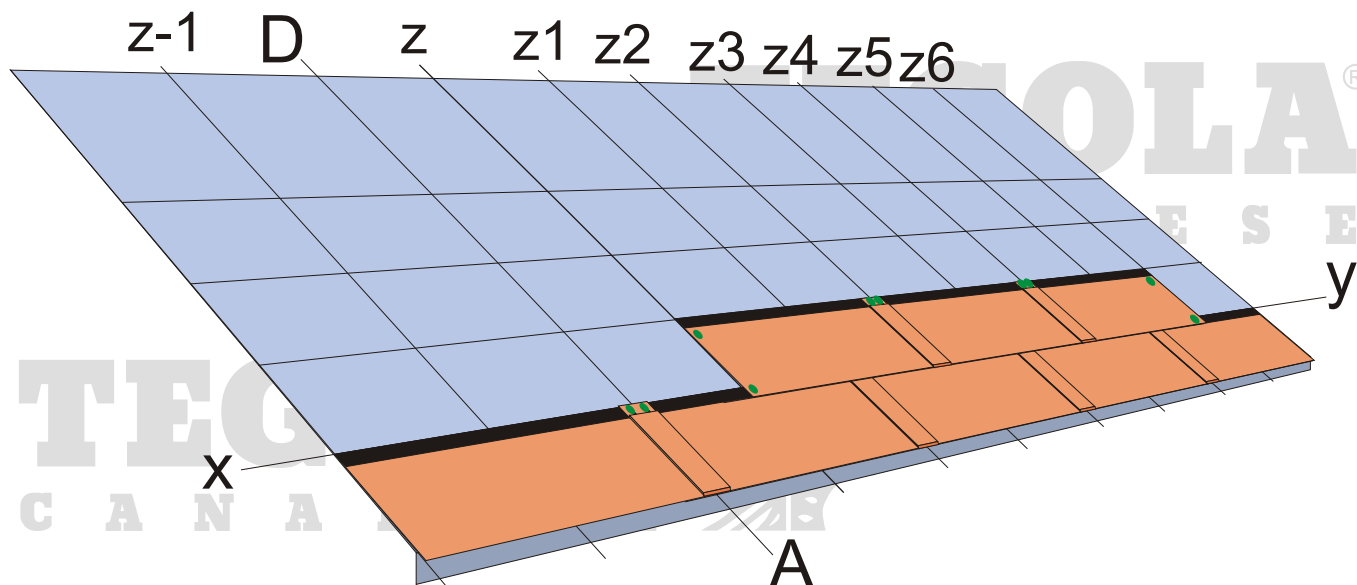

Picture Nr. 10 - Installation of the Compact Clip

SLOPES

Minimum slope for the installation of the shingles with nails is 35% (19 degrees)

For roofs in the mountainside or with a pitch longer than 7,00 ml, please visit our web site or contact our Customer Service.

FIXING WITH NAILS

Use large headed roofing nails for the roof, stainless steel with high adherence, with a length suitable to the thickness and type of roof deck (minimum length 25 mm).

Apply 6 steel nails AISI 304 on each bituminous shingle, COMPACT, positioned exactly as shown in Picture 11.

The 2 nails fixed at the lower part of the shingles must be positioned in such a manner as to simultaneously nail the shingles underneath. The 2 nails (marked in red) are applied with the installation of "Compact Clip".

N.B.: For slopes exceeding 160% (60 degrees) apply 8 nails position as shown in Picture 12.

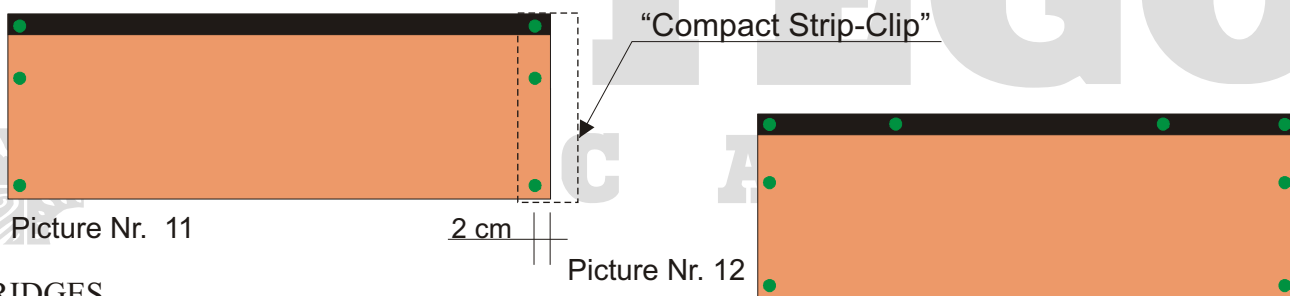

RIDGES

Install COMPACT shingles on both sides of the roof till the ridge line and cut the shingle which overshoot the ridge.

Waterproof the ridge, installing over the ridge TOP ROLL, a self adhesive membrane. Remove the protection on the reverse side (Pict. Nr. 12).

Remove the protection on the reverse side of the ridge tile (Pict. Nr. 3) and fix it with 2 nails 35 mm length see picture 13-14. Once the ridge has been fixed, remove the protection film from the ridge tile.

Repeat this installation method until all ridges are put down.

The exposure of the ridge shingles is 25 cm (Pict. Nr. 14).

The ridges must bond each other; if necessary press down the ridge tiles with hands.

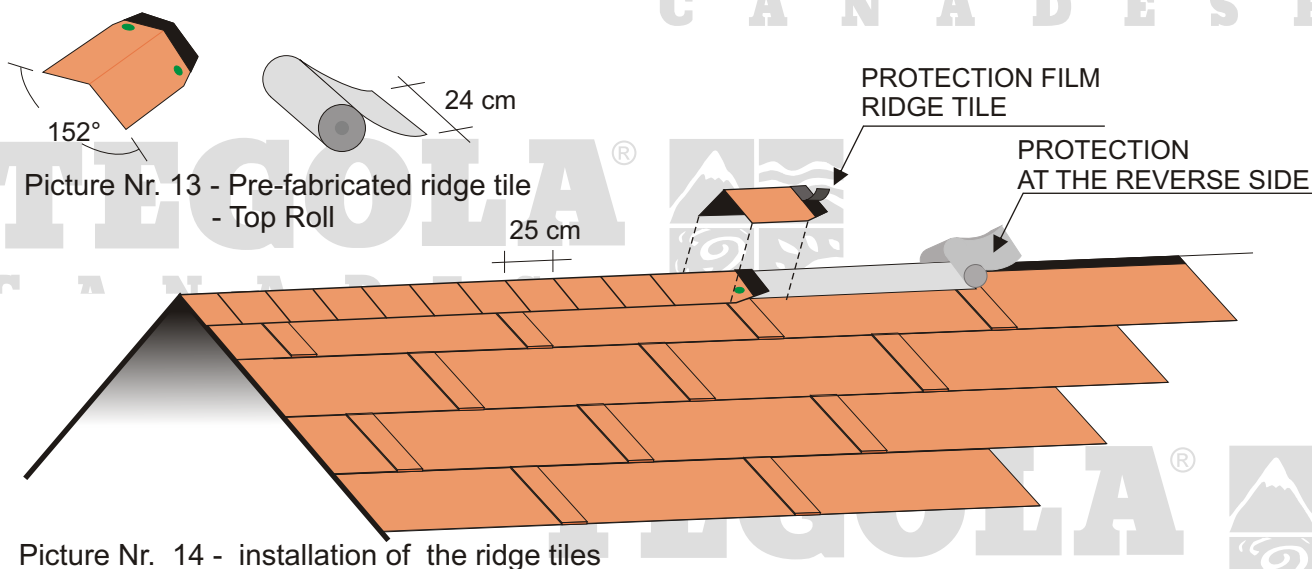

VALLEYS

Install a valley gutter (Pict. Nr. 15) in correspondence of the valley (Pict. Nr. 17). The valley gutter has to be installed before marking the roof.

At 10 cm from the center line of the valley apply a line of Bitustick mastic (Pict. Nr. 17).

Install the shingles as to former indications and cut them at the center of the valley (Pict. Nr. 18) so that the cutting side meets the central fold of the valley (Pict. Nr. 16).

Seal the joint between shingles and valley with a line of Bitustick mastic (Pict. Nr. 16-18).

Nails should not be used within at least 30 cm of the center line.

Picture Nr. 15 - Flashing (example)

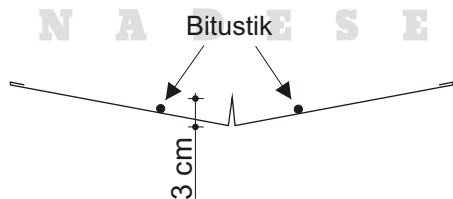

Picture Nr. 16 - Flashing (example)



Picture Nr. 17 - Installation of the valley

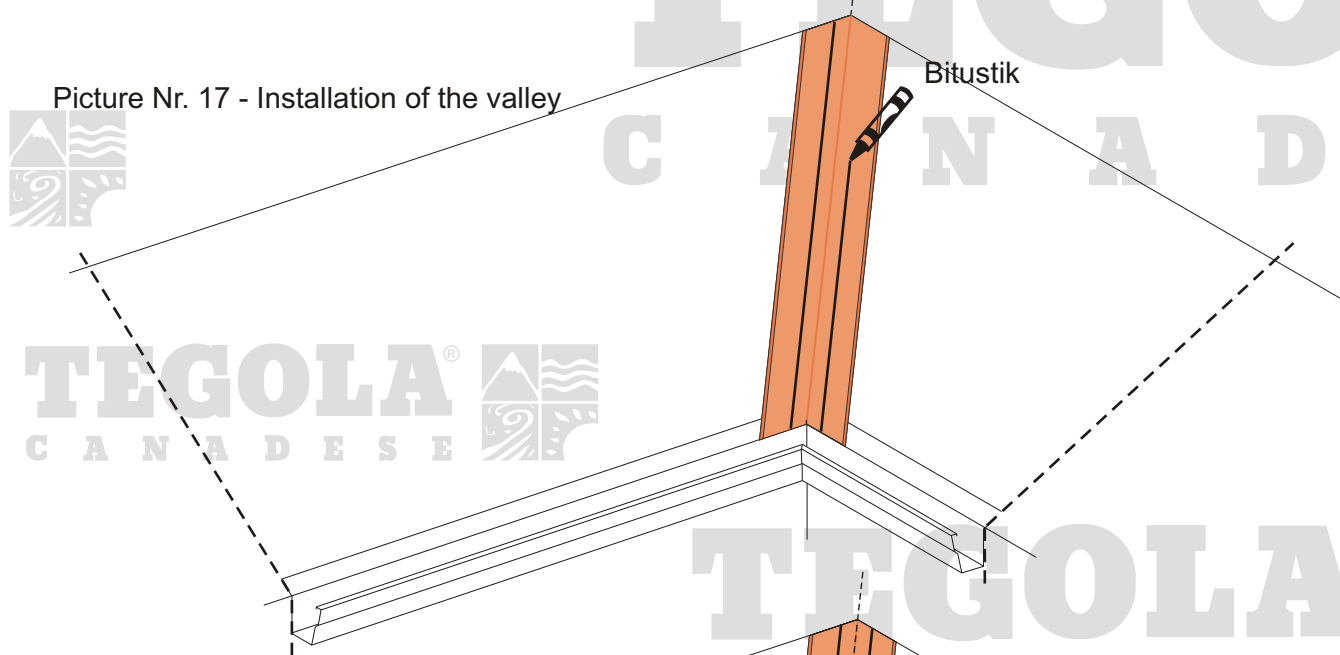

Picture Nr. 18 - Installation of the shingles

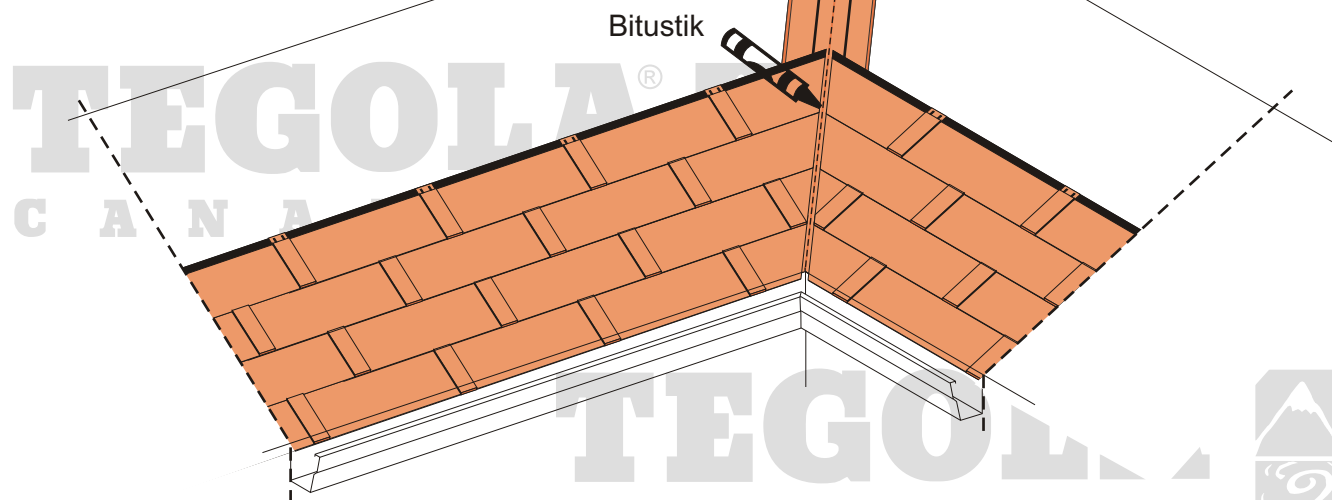

DETAILS

All the flashings (joints, chimneys, valley, etc...) can be carried out with copper flashings or with bituminous membranes; and everything will be simplified by using the products TEGOLA CANADESE.

Roof accessories such as: roof windows, snow stops, aerators and other accessories from Tegola Canadese make the installation and finishing of the roof easier.

The shingles PRESTIGE COMPACT, are supplied with self-adhesive strip that stick the shingles together, avoiding the wind to lift them up. With cold weather or in very windy areas this does not automatically happen and the adhesive points have to be heated up with a leister or with a torch, and the shingles have to be pressed down to assure that they stick together.

WARNING

- DO NOT STORE THE PALLET ONE ON THE TOP OF THE OTHER TO AVOID THAT THE BITUMINOUS SHINGLES STICK TOGETHER INSIDE THE BUNDLE.
- DO NOT EXPOSE THE PALLETS TO ATMOSPHERIC AGENTS NOR TO HEAT.
- DO NOT EXPOSE THE PALLETS TO ATMOSPHERIC AGENTS NOR TO HEAT.
- SHINGLES MUST NOT BE INSTALLED WHEN THEIR TEMPERATURE IS LESS THAN 10°C.
- PAY MAXIMUM ATTENTION WHEN BENDING AND APPLAING SHINGLES WHITH TORCH ON SYSTEM TO AVOID THE EVENTUAL DELAMINATION OF COPPER FROM THE BITUMINOUS SUPPORT.
- IMMEDIATELY PRIOR TO THE INSTALLATION OF THE ROOF, THE SHINGLES SHOULD
- BE GENTLY CURVED
- IN SNOWY AREAS APPLY COPPER SNOW STOPS IN SUFFICIENT QUANTITY

TEGOLA CANADESE

TEGOLA[®]
CANADESE

TEGOLA[®] 
CANADESE

TEGOLA[®] 
CANADESE